

Name: _____

Date: _____

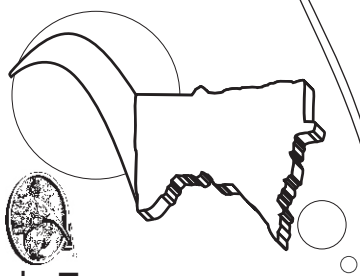

Minnesota Space Frontier Society.

433 South 7th Street
Suite 1808
Minneapolis, MN 55415
Voice: 612-333-1872
<http://www.freemars.org/>
e-mail: info@freemars.org

National Space Society
A chapter of
and
THE MARS SOCIETY

Moon Explorer



Name: _____

Date: _____



**Minnesota Space
Frontier Society.**

433 South 7th Street
Suite 1808
Minneapolis, MN 55415
Voice: 612-333-1872
<http://www.freemars.org/>
e-mail: info@freemars.org

A chapter of
National Space Society and
THE MARS SOCIETY



Future Spaceship

Name: _____

Date: _____

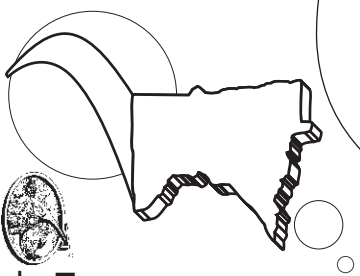

**Minnesota Space
Frontier Society.**

433 South 7th Street
Suite 1808
Minneapolis, MN 55415
Voice: 612-333-1872
<http://www.freemars.org/>
e-mail: info@freemars.org

National Space Society
A chapter of
THE MARS SOCIETY

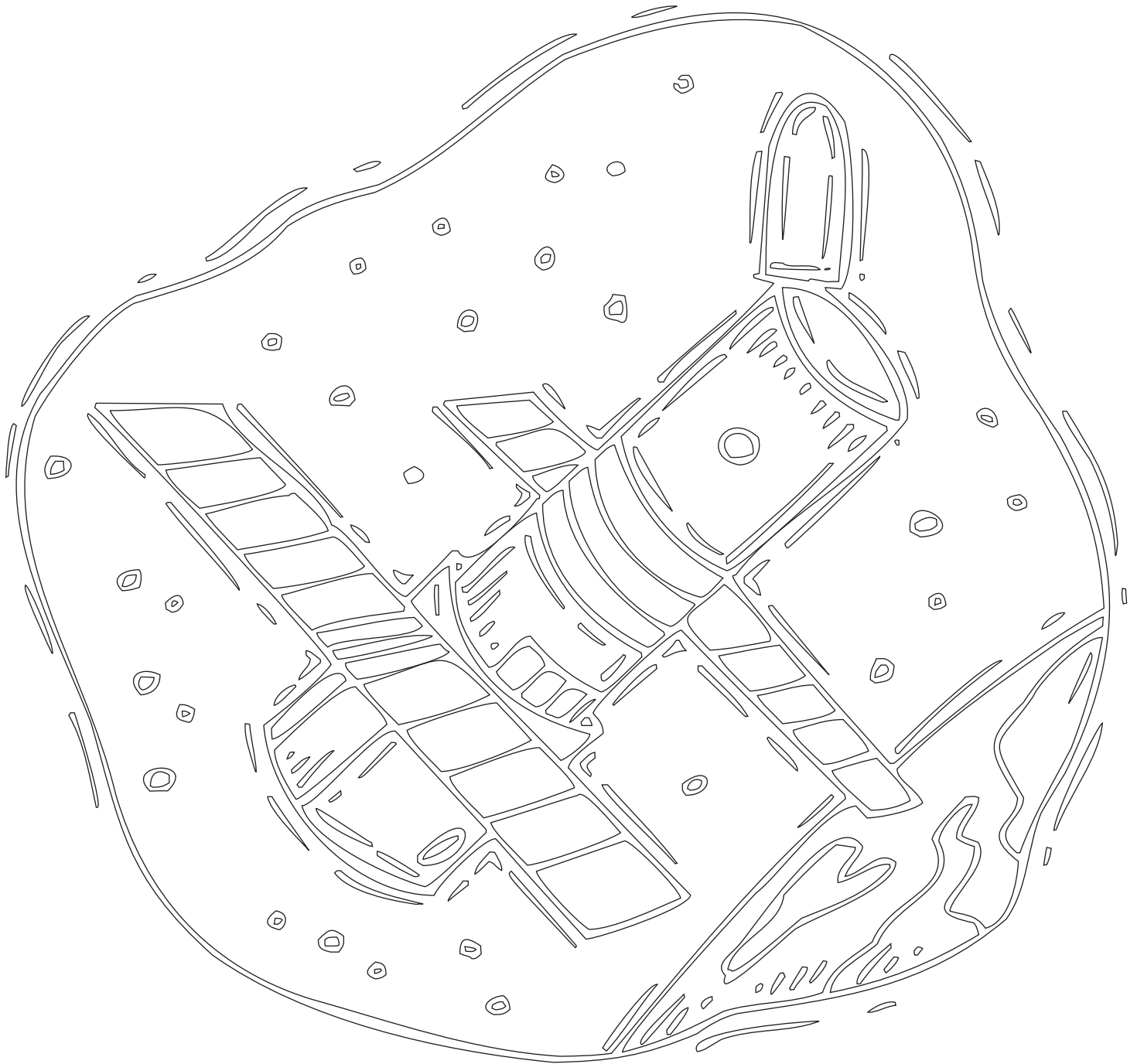

Hubble Space Telescope

Name: _____
Date: _____



**Minnesota Space
Frontier Society.**

433 South 7th Street
Suite 1808
Minneapolis, MN 55415
Voice: 612-333-1872
<http://www.freemars.org/>
e-mail: info@freemars.org

A chapter of
National Space Society and
THE MARS SOCIETY

Shuttle Landing

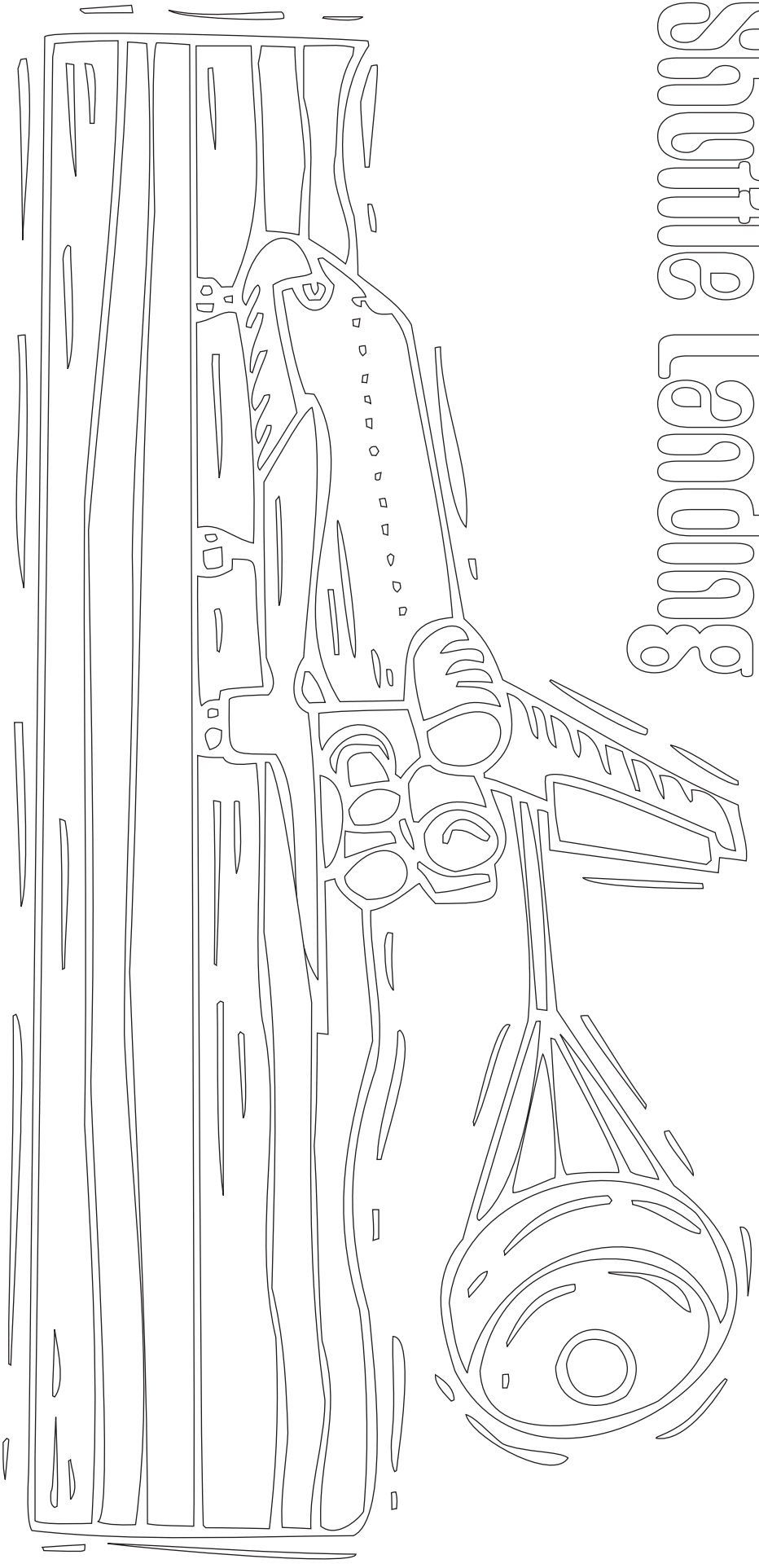

Name: _____

Date: _____

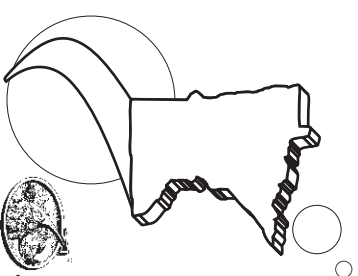

**Minnesota Space
Frontier Society.**

433 South 7th Street
Suite 1808

Minneapolis, MN 55415

Voice: 612-333-1872

<http://www.freemars.org/>

e-mail: info@freemars.org

A chapter of

National Space Society

and

THE MARS SOCIETY

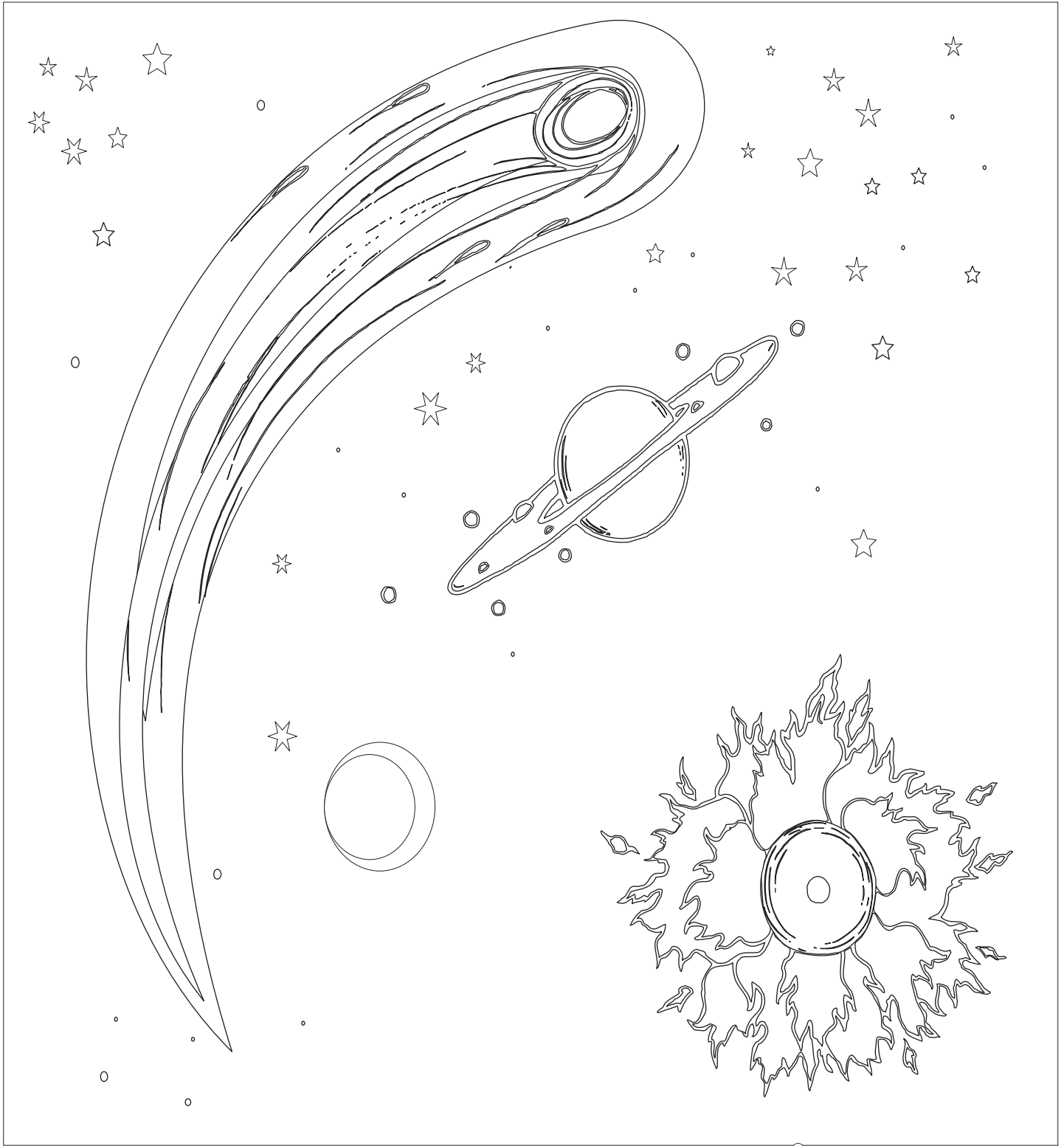

Name: _____
Date: _____



**Minnesota Space
Frontier Society.**

433 South 7th Street
Suite 1808
Minneapolis, MN 55415
Voice: 612-333-1872
<http://www.freemars.org/>
e-mail: info@freemars.org

A chapter of
National Space Society and
THE MARS SOCIETY

Mars Exploration Rover

Name: _____

Date: _____

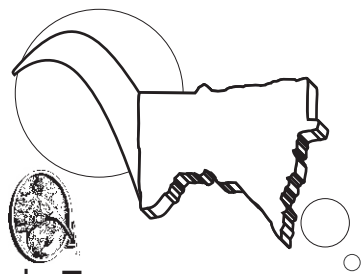
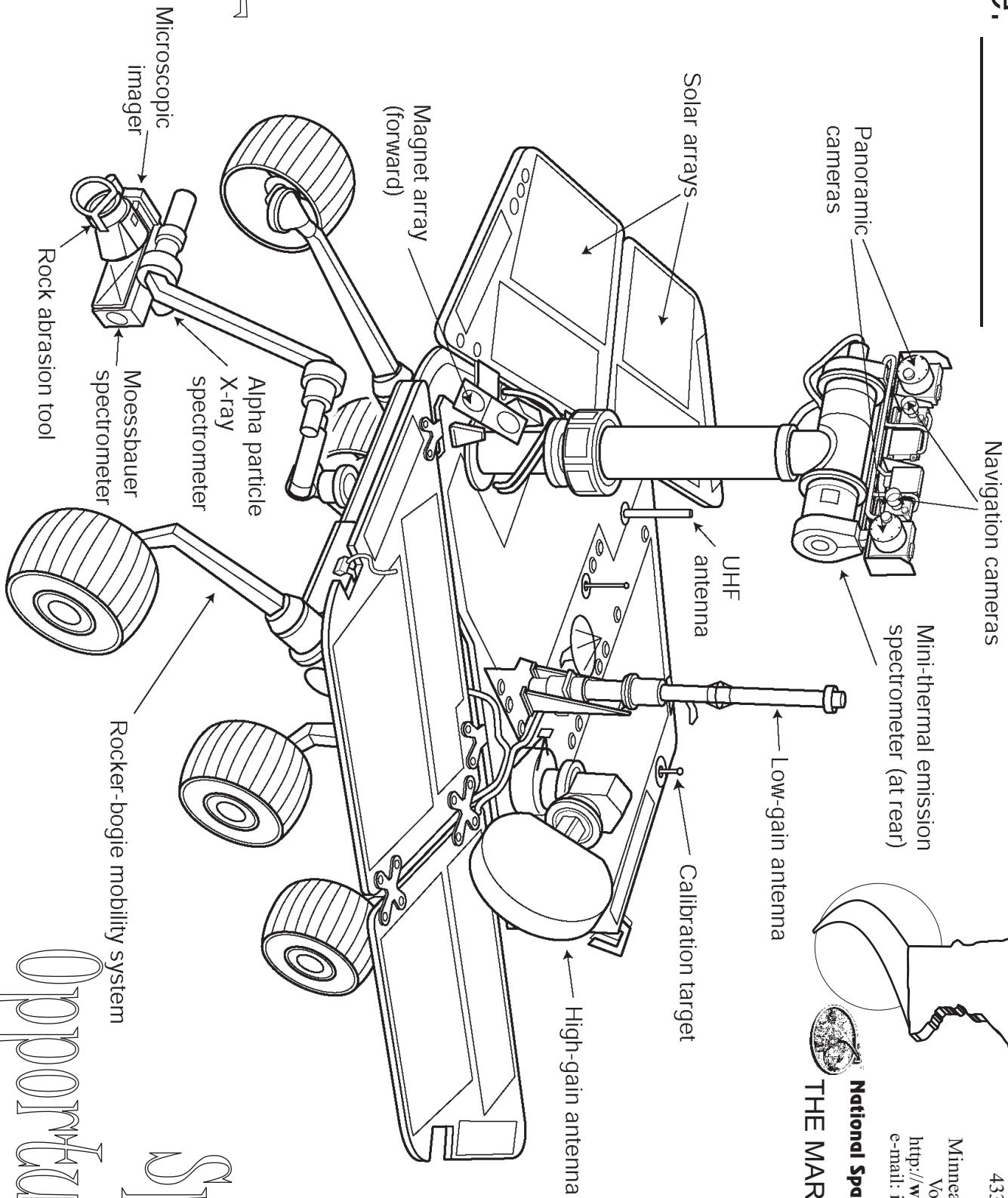

Minnesota Space Frontier Society.
 433 South 7th Street
 Suite 1808
 Minneapolis, MN 55415
 Voice: 612-333-1872
<http://www.freemars.org/>
 e-mail: info@freemars.org
 A chapter of
National Space Society
 and
THE MARS SOCIETY

Opportunity
Spirit

Name: _____

Date: _____

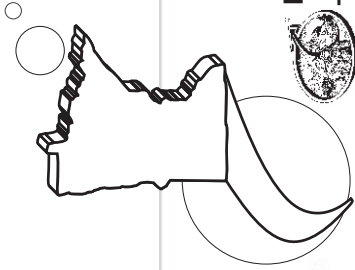

Minnesota Space Frontier Society.

433 South 7th Street

Suite 1808

Minneapolis, MN 55415

Voice: 612-333-1872

<http://www.freemars.org/>

e-mail: info@freemars.org

National Space Society



A chapter of

and

THE MARS SOCIETY

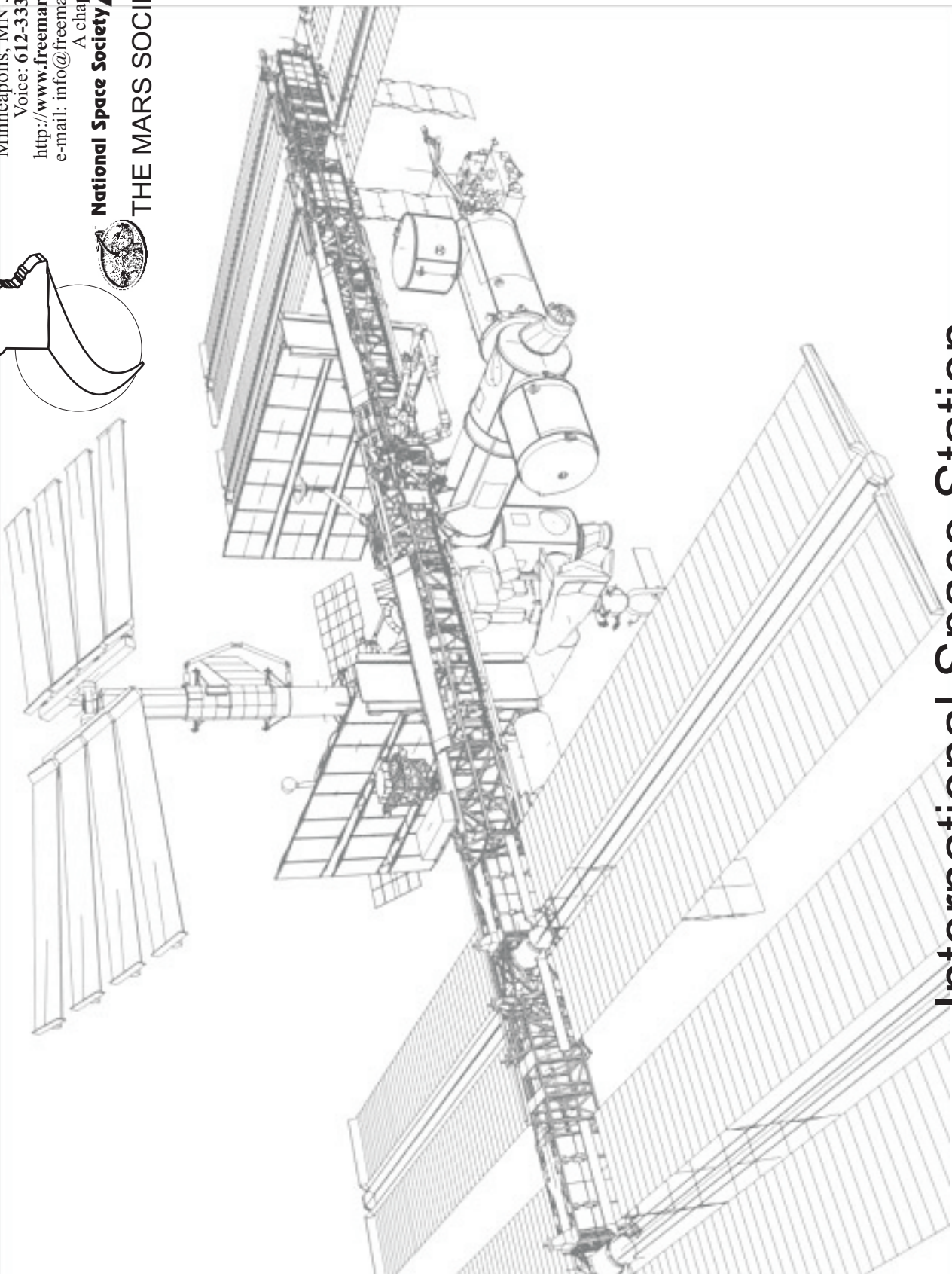

International Space Station